

OUTLINE DIMENSIONS

MODEL EV3285

UNIT mm

EIZO Corporation

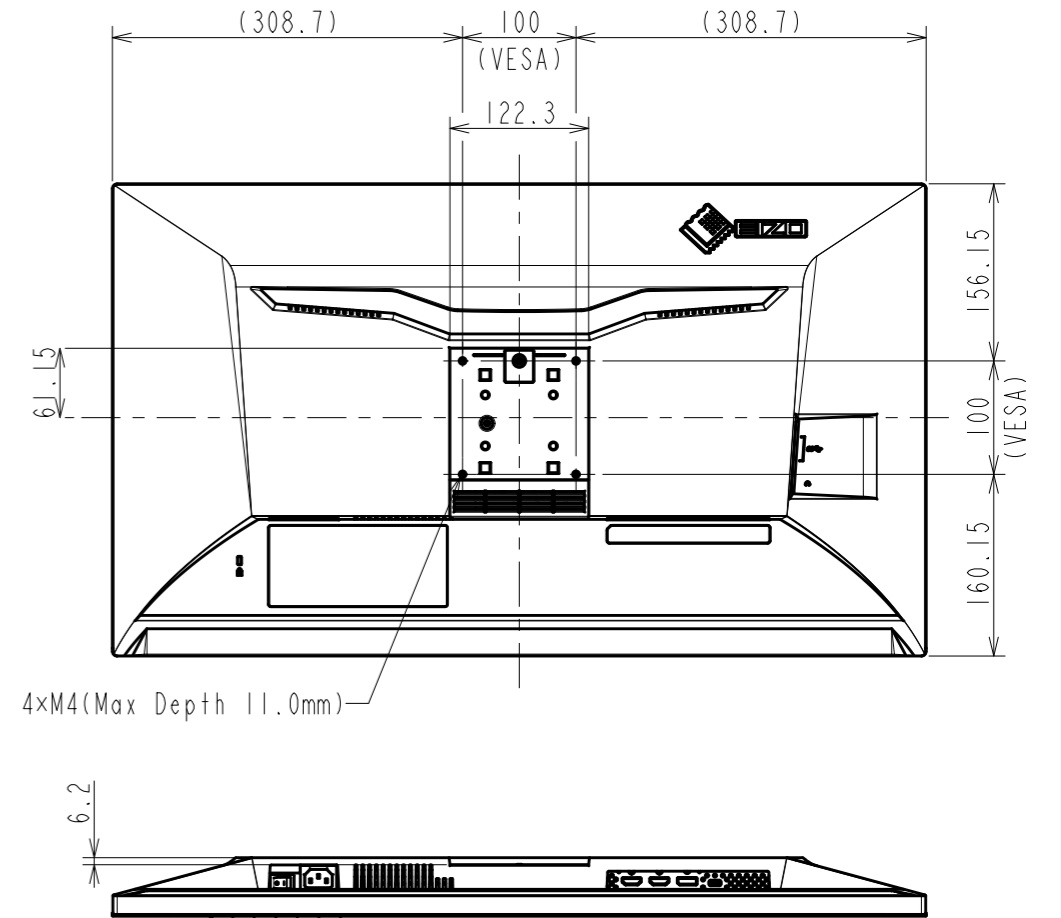
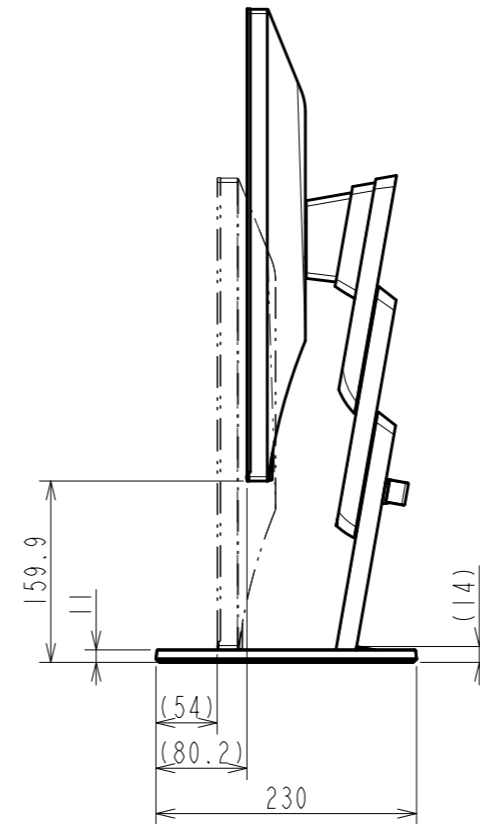
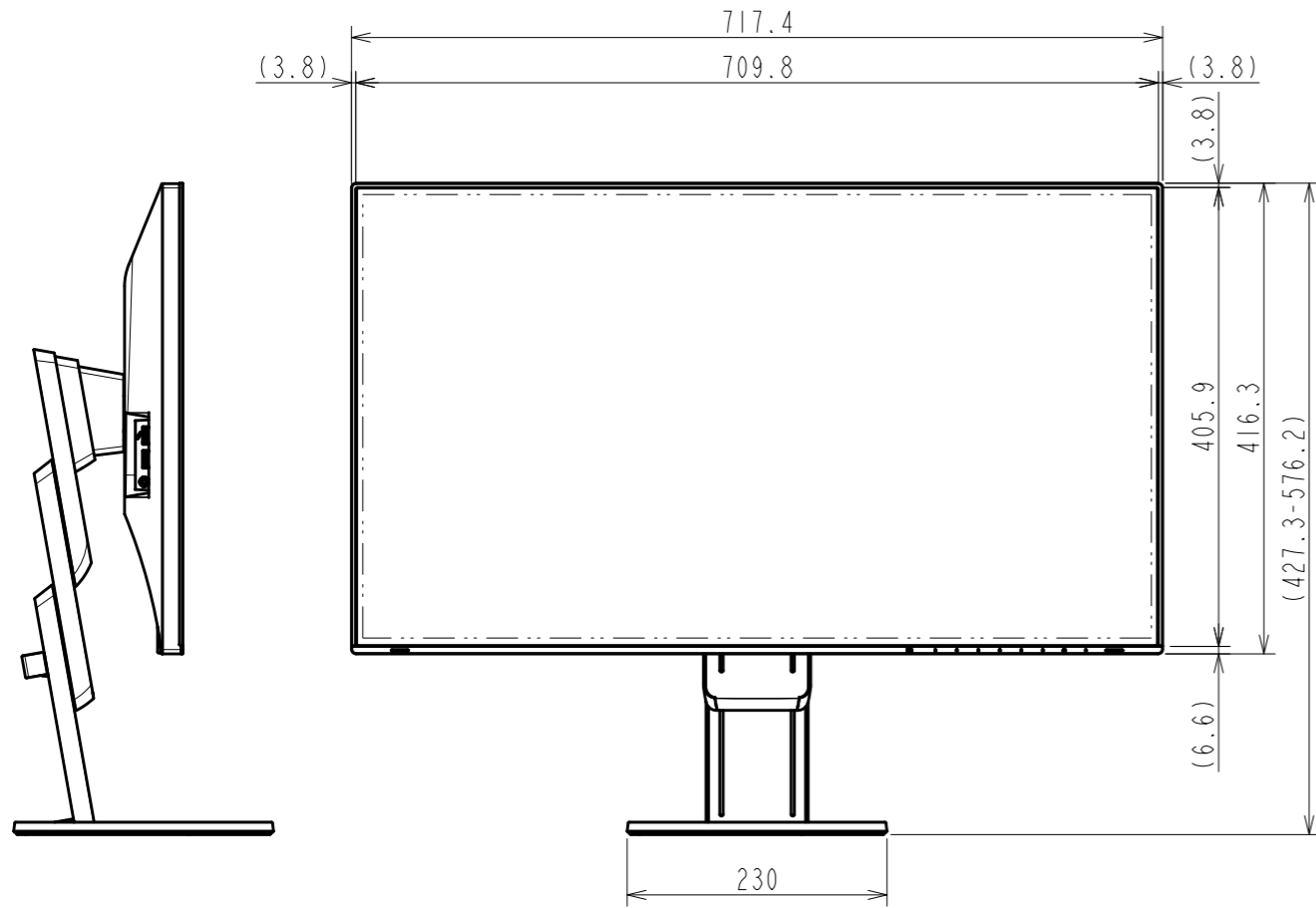
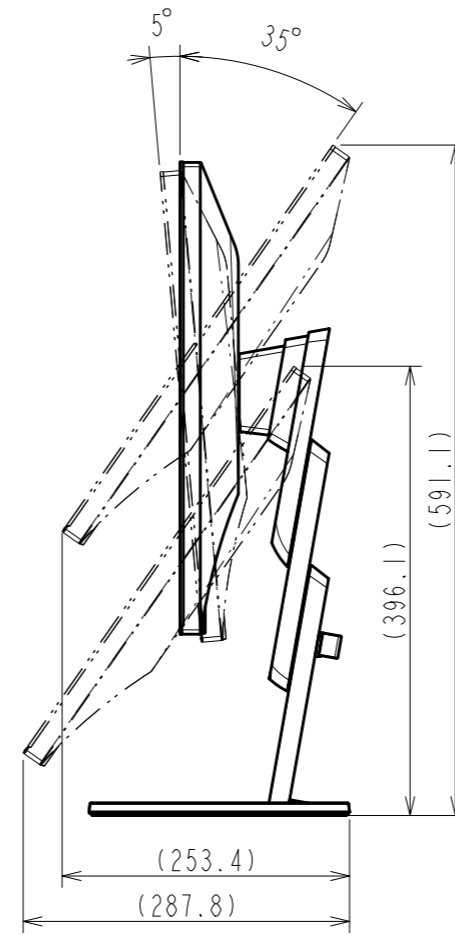
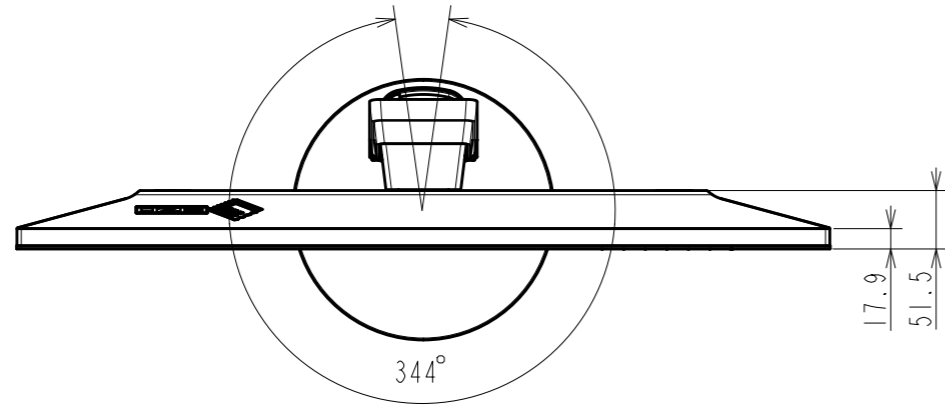

OUTLINE DIMENSIONS

MODEL EV3285

UNIT mm

EIZO Corporation

